



Download the
ONECTA app
STAND BY ME
Discover our service offer



Operation manual

Daikin room air conditioner

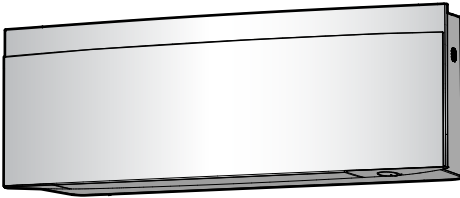

FTXTJ30A2V1BW
FTXTJ30A2V1BB

Operation manual
Daikin room air conditioner

English

Table of Contents

1 About the documentation 2
 1.1 About this document..... 2

2 User safety instructions 2
 2.1 Instructions for safe operation 3

3 About the system 4
 3.1 Indoor unit 4
 3.1.1 Daikin eye indication lamp 4
 3.2 About the user interface 5
 3.2.1 Components: Wireless remote control 5
 3.2.2 To operate the wireless remote control..... 5

4 Before operation 5
 4.1 To insert the batteries..... 5
 4.2 To mount the wireless remote control magnetic holder..... 6
 4.3 To turn on the power supply 6
 4.4 Indoor unit setting 6
 4.4.1 Open the front panel 6
 4.4.2 Wireless LAN connection..... 6
 4.4.3 Vertical airflow function 8

5 Operation 9
 5.1 Operation range 9
 5.2 Operation mode and temperature setpoint..... 9
 5.2.1 To start/stop operation mode and to set the temperature..... 9
 5.3 Airflow rate 10
 5.3.1 To adjust the airflow rate..... 10
 5.4 Airflow direction 10
 5.4.1 To adjust vertical airflow direction 11
 5.4.2 To adjust horizontal airflow direction..... 11
 5.4.3 To use 3D airflow direction 11
 5.4.4 To start/stop Comfort airflow operation..... 11
 5.5 Intelligent eye operation 11
 5.5.1 To start/stop Intelligent eye operation..... 12
 5.6 Powerful operation 12
 5.6.1 To start/stop Powerful operation 12
 5.7 Econo operation 12
 5.7.1 To start/stop Econo operation..... 12
 5.8 Outdoor unit quiet operation..... 12
 5.8.1 To start/stop Outdoor unit quiet operation 12
 5.9 Flash Streamer (air cleaning) operation 13
 5.9.1 To start/stop Flash Streamer (air cleaning) operation..... 13
 5.10 Fireplace logic operation 13
 5.10.1 To start/stop Fireplace logic operation 13
 5.11 Clock and timer setting 13
 5.11.1 The clock setting 13
 5.11.2 OFF/ON timer operation 14
 5.11.3 Weekly timer operation 15

6 Energy saving and optimum operation 16

7 Maintenance and service 16
 7.1 Overview: Maintenance and service 16
 7.2 To clean the indoor unit and wireless remote control..... 17
 7.3 To clean the front panel..... 17
 7.4 To open the front panel 17
 7.5 To clean the air filters 17
 7.6 To clean the titanium apatite deodorising filter and the silver particle filter (Ag-ion filter) 18
 7.7 To replace the titanium apatite deodorising filter and the silver particle filter (Ag-ion filter) 18
 7.8 To close the front panel..... 18
 7.9 To take following items into account before a long idle period.. 18

8 Troubleshooting 19

1 About the documentation

1.1 About this document

Thank you for purchasing this product. Please:

- Read the documentation carefully before operating the user interface to ensure the best possible performance.
- Request the installer to inform you about the settings that he used to configure your system. Check if he has filled in the installer settings tables. If NOT, request him to do so.
- Keep the documentation for future reference.

Target audience

End users

i INFORMATION

This appliance is intended to be used by expert or trained users in shops, in light industry, and on farms, or for commercial and household use by lay persons.

Documentation set

This document is part of a documentation set. The complete set consists of:

- **General safety precautions:**
 - Safety instructions that you must read before operating your system
 - Format: Paper (in the box of the indoor unit)
- **Operation manual:**
 - Quick guide for basic usage
 - Format: Paper (in the box of the indoor unit)
- **User reference guide:**
 - Detailed step-by-step instructions and background information for basic and advanced usage
 - Format: Digital files on <https://www.daikin.eu>. Use the search function  to find your model.

Latest revisions of the supplied documentation may be available on the regional Daikin website or via your installer.

Scan the QR code below to find the full documentation set and more information about your product on Daikin website.



The original instructions are written in English. All other languages are translations of the original instructions.

2 User safety instructions

Always observe the following safety instructions and regulations.

2.1 Instructions for safe operation



WARNING: MILDLY FLAMMABLE MATERIAL

The refrigerant inside this unit is mildly flammable.



CAUTION

The indoor unit contains radio equipment, minimum separation distance between the radiating part of the equipment and the user is 10 cm.



CAUTION

Do NOT insert fingers, rods or other objects into the air inlet or outlet. When the fan is rotating at high speed, it will cause injury.



WARNING

- Do NOT modify, disassemble, remove, reinstall or repair the unit yourself as incorrect dismantling or installation may cause an electrical shock or fire. Contact your dealer.
- In case of accidental refrigerant leaks, make sure there are no naked flames. The refrigerant itself is entirely safe, non-toxic and mildly flammable, but it will generate toxic gas when it accidentally leaks into a room where combustible air from fan heaters, gas cookers, etc. is present. Always have qualified service personnel confirm that the point of leakage has been repaired or corrected before resuming operation.



CAUTION

ALWAYS use the wireless remote control or other user interface (if applicable) to adjust the position of the flaps and louvers. When the flaps and louvers are swinging and you move them forcibly by hand, the mechanism will break.



CAUTION

NEVER expose little children, plants or animals directly to the airflow.



WARNING

Do NOT place a flammable spray bottle near the air conditioner and do NOT use sprays near the unit. Doing so may result in a fire.



CAUTION

Do NOT operate the system when using a room fumigation-type insecticide. Chemicals could collect in the unit, and endanger the health of people who are hypersensitive to chemicals.



WARNING

- The refrigerant inside the unit is mildly flammable, but normally does NOT leak. If the refrigerant leaks in the room and comes in contact with fire from a burner, a heater, or a cooker, this may result in fire, or the formation of a harmful gas.
- Turn OFF any combustible heating devices, ventilate the room, and contact the dealer where you purchased the unit.
- Do NOT use the unit until a service person confirms that the part from which the refrigerant leaked has been repaired.



WARNING

- Do NOT pierce or burn refrigerant cycle parts.
- Do NOT use cleaning materials or means to accelerate the defrosting process other than those recommended by the manufacturer.
- Be aware that the refrigerant inside the system is odourless.



WARNING

The appliance shall be stored so as to prevent mechanical damage and in a well-ventilated room without continuously operating ignition sources (e.g. open flames, an operating gas appliance, or an operating electric

3 About the system

heater). The room size shall be as specified in the General safety precaution.

DANGER: RISK OF ELECTROCUTION

To clean the air conditioner or air filter, be sure to stop operation and turn all power supplies OFF. Otherwise, an electrical shock and injury may result.

CAUTION

After a long use, check the unit stand and fitting for damage. If damaged, the unit may fall and result in injury.

CAUTION

Do NOT touch the heat exchanger fins. These fins are sharp and could result in cutting injuries.

WARNING

Be careful with ladders when working in high places.

WARNING

Improper detergents or cleaning procedure may cause damage on plastic components or water leakage. Splashed detergent on electric components, such as motors, may cause failure, smoke or ignition.

DANGER: RISK OF ELECTROCUTION

Before cleaning, be sure to stop the operation, turn the breaker OFF or pull out the supply cord. Otherwise, an electrical shock and injury may result.

WARNING

Stop operation and shut OFF the power if anything unusual occurs (burning smells etc.).

Leaving the unit running under such circumstances may cause breakage, electrical shock or fire. Contact your dealer.

3 About the system



WARNING: MILDLY FLAMMABLE MATERIAL

The refrigerant inside this unit is mildly flammable.



CAUTION

The indoor unit contains radio equipment, minimum separation distance between the radiating part of the equipment and the user is 10 cm.



NOTICE

Do NOT use the system for other purposes. In order to avoid any quality deterioration, do NOT use the unit for cooling precision instruments, food, plants, animals, or works of art.

3.1 Indoor unit



CAUTION

Do NOT insert fingers, rods or other objects into the air inlet or outlet. When the fan is rotating at high speed, it will cause injury.



INFORMATION

The sound pressure level is less than 70 dBA.



WARNING

- Do NOT modify, disassemble, remove, reinstall or repair the unit yourself as incorrect dismantling or installation may cause an electrical shock or fire. Contact your dealer.
- In case of accidental refrigerant leaks, make sure there are no naked flames. The refrigerant itself is entirely safe, non-toxic and mildly flammable, but it will generate toxic gas when it accidentally leaks into a room where combustible air from fan heaters, gas cookers, etc. is present. Always have qualified service personnel confirm that the point of leakage has been repaired or corrected before resuming operation.

ON/OFF button

If the user interface (e.g. wireless remote control) is missing, you can use the ON/OFF button on the indoor unit to start/stop operation. When operation is started using this button, the following settings are used:

- Operation mode = Automatic
- Temperature setting = 25°C
- Airflow rate = Automatic

3.1.1 Daikin eye indication lamp

The Daikin eye colour will change according to operation.

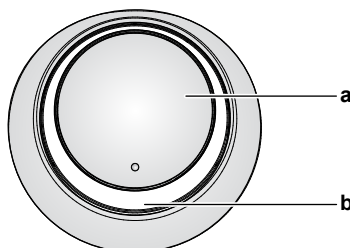

- a ON/OFF button
- b Daikin eye (with infrared signal receiver)

Operation	Daikin eye colour
Automatic	Red/blue

Operation	Daikin eye colour
Cooling	Blue
Heating	Red
Fan only	White
Drying	Green
Timer operation	Orange ^(a)

^(a) When the OFF/ON timer or Weekly timer operation is set, the Daikin eye periodically changes to orange. After lighting orange for about 10 seconds, it returns to the colour of the operation mode for 3 minutes. **Example:** When the timer is set during cooling operation, the Daikin eye will periodically light orange for 10 seconds, and then switch to blue for 3 minutes.

3.2 About the user interface

Wireless remote control



INFORMATION

The indoor unit is delivered with the wireless remote control as the user interface. This manual describes only operation with this user interface. If another user interface is connected, refer to the operation manual of the connected user interface.

- **Direct sunlight.** Do NOT expose the wireless remote control to direct sunlight.
- **Dust.** Dust on the signal transmitter or receiver will reduce sensitivity. Wipe off dust with a soft cloth.
- **Fluorescent lights.** Signal communication might be disabled if fluorescent lamps are in the room. In that case, contact your installer.
- **Other appliances.** If the wireless remote control signals operate other appliances, move the other appliances, or contact your installer.
- **Curtains.** Make sure that curtains or other objects do NOT block the signal between the unit and the wireless remote control.



NOTICE

- Do NOT drop the wireless remote control.
- Do NOT let the wireless remote control get wet.

3.2.1 Components: Wireless remote control

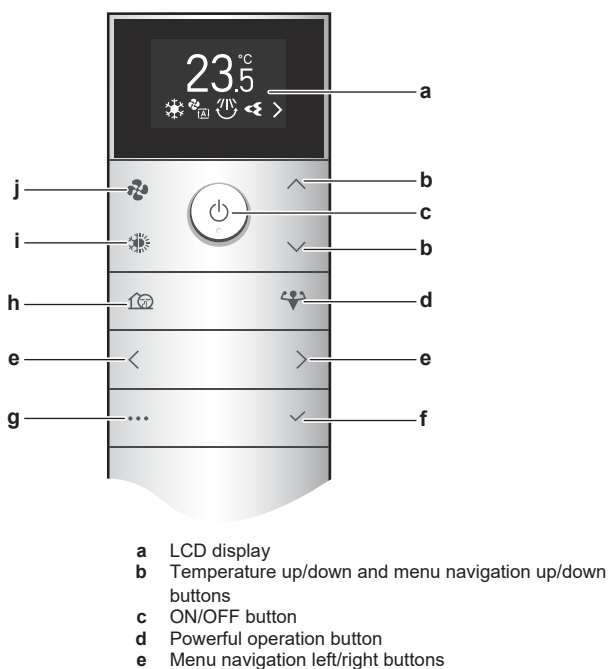

3.2.2 To operate the wireless remote control

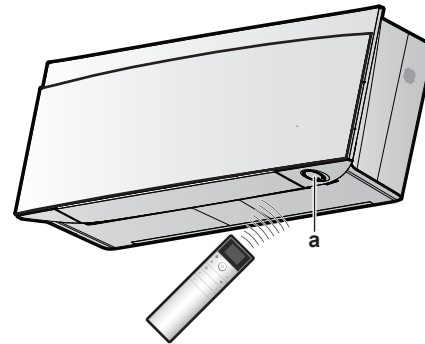

a Infrared signal receiver

Note: Make sure that there are no obstacles within 500 mm under the infrared signal receiver. They may influence reception performance of the wireless remote control.

- 1 Aim the signal transmitter at the infrared signal receiver on the indoor unit (maximum distance for communication is 7 m).

Result: When the indoor unit receives a signal from the wireless remote control, you will hear a sound:

Sound	Description
Beep-beep	Operation starts.
Beep	Setting changes.
Long beep	Operation stops.

4 Before operation



INFORMATION

This manual contains only few settings before operation.

For mode setting before operation, refer to the **user reference guide** located on Daikin website under "Documentation". Scan the QR code in "1.1 About this document" [p 2] OR go to <https://www.daikin.eu> and use the search function 🔍 to find your model.

- **Indoor unit setting:** brightness of the Daikin eye, open the front panel, wireless LAN connection, vertical airflow function, indoor unit installation position, keep dry function
- **Wireless remote control setting:** LCD contrast, LCD brightness, LCD turn off time, automatic send after select, channels of the indoor unit infrared receiver

4.1 To insert the batteries

The batteries will last for about 1 year.

- 1 Remove the back cover.
- 2 Insert both batteries at once.
- 3 Put the cover back.

4 Before operation

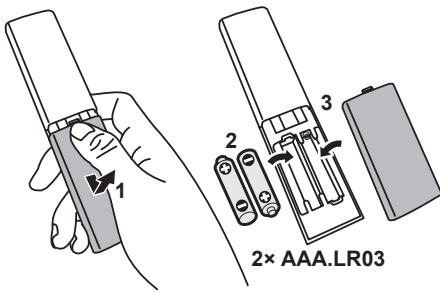

i INFORMATION

- Low energy of battery indicates blinking **i** on the LCD display (first position).
- When the batteries are running low, functions of the wireless remote control are suspended and you can only turn OFF the operation, all timer functions are OFF. Replace the batteries as soon as possible.
- ALWAYS replace both batteries together.

4.2 To mount the wireless remote control magnetic holder

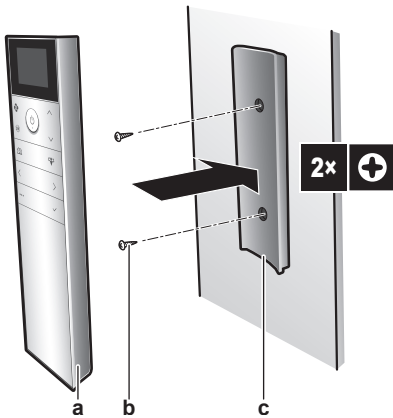

- a Wireless remote controller
- b Screws (field supply)
- c Wireless remote controller magnetic holder

- Choose a place where the signals reach the unit.
- Attach the holder with screws to the wall or a similar location.
- Hang the wireless remote control on the holder.

i INFORMATION

The wireless remote control holder is magnetic. Make sure to install the holder with the right side up.

4.3 To turn on the power supply

- Turn the circuit breaker on.

Result: The flap of the indoor unit will open and close to set the reference position.

4.4 Indoor unit setting

- Enter the main menu by pressing **...** and navigate to the indoor unit setting menu using **<** and **>**. Press **✓** to enter the menu.

Indoor unit setting menu



- Perform the settings listed below.
- Press **✓** to return to the main menu or press **...** to exit to the home screen.

4.4.1 Open the front panel

The front panel opens automatically when the operation starts. When you want to open the front panel when the operation is OFF, use this feature. **Example:** during maintenance.

To open the front panel using the wireless remote control

- Make sure the operation is OFF. If not, turn it OFF using **⏻**.
- In the indoor unit setting menu, navigate to the open the front panel screen using **<** and **>**.

Open the front panel screen



- Press **✓** to confirm.

Result: The front panel opens.

- Press **✓** again to close the front panel or press **...** to return to the home screen.

4.4.2 Wireless LAN connection

Simply connect your unit to your home network and download the app to change the thermostat, set temperature schedules, review your energy consumption and more.

For details on specifications, setting methods, FAQ, troubleshooting tips, visit app.daikineurope.com.



The customer is responsible for providing:

- Smartphone or tablet with minimum supported version of Android or iOS, specified on app.daikineurope.com.
- Internet line and communication device, such as a modem, router, etc.
- Wireless LAN access point
- Installed free ONECTA app

Note: If needed, the SSID (Service Set Identifier) and the KEY (password) are located on the unit.

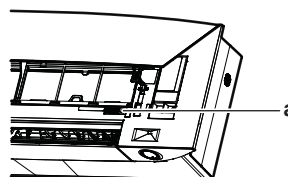

a Label with the SSID and the KEY

Precautions when using the wireless LAN

Do NOT use near:

- **Medical equipment.** E.g. persons using cardiac pacemakers or defibrillators. This product may cause electromagnetic interference.
- **Auto-control equipment.** E.g. automatic doors or fire alarm equipment. This product may cause faulty behaviour of the equipment.
- **Microwave oven.** It may affect wireless LAN communications.

To install the ONECTA app

- 1 Go to Google Play (for Android devices) or the App Store (for iOS devices) and search for "ONECTA".
- 2 Follow the directions on the screen to install the ONECTA app.

Search the app directly using the QR on the wireless remote control display

- 1 Enter the main menu by pressing and navigate to the wireless remote control setting menu using and .
- 2 Press to enter the menu.

Wireless remote control setting menu



- 3 Navigate to the QR code screen using and .
- 4 Scan the QR code by smartphone or other smart devices.

Result: The QR code will re-direct you to the App Store or Google Play.



- 5 Follow the directions on the screen to install.

INFORMATION

If the QR code is difficult to read, switch the displayed QR code using or , then try again.

To set the wireless connection

There are two options to connect the wireless adapter to your home network.

- Using a smart device (smartphone, tablet) and SSID (Service Set Identifier) and KEY (password)
- Using the WPS (Wi-Fi Protected Setup) button on your Wi-Fi router.

For more information and FAQ, refer to app.daikineurope.com.

Note: Setting is done by the wireless remote control in the wireless LAN setting menu. During setting, always aim the wireless remote control at the infrared signal receiver on the unit.

INFORMATION

Make sure operation is stopped before setting the wireless connection. Connection CANNOT be made when the unit is in operation.

- 1 **Stop operation** before setting the wireless connection.
- 2 Make sure the wireless router is close enough to the unit and nothing obstructs the signal.

Menu	Description
	<ul style="list-style-type: none"> ▪ ON = Wireless LAN ON (AP mode/RUN mode (SSID + KEY) connection setting) ▪ OFF = Wireless LAN OFF
	Exit to setting menu
	WPS connection setting
	Reset to factory default
	Connection status check

To connect the wireless LAN to your home network

The wireless adapter can be connected to your home network using the:

- WPS button (Wi-Fi Protected Setup) on the router (if present),
- The SSID (Service Set Identifier) and the KEY (password) - located on the unit.

- 1 In the indoor unit setting menu, navigate to the Wireless LAN connection setting using and . Press to enter the menu.

Indoor unit setting menu



Wireless LAN connection setting



- 2 Change the setting to ON using and . Press to confirm your selection.

Wireless LAN signal ON



Wireless LAN signal OFF



Result: The connection animation is displayed on the screen for 5 seconds and the wireless LAN status screen is displayed.

- 3 Continue setting using the WPS button or the SSID and KEY.

To connect using the WPS button

- 1 Navigate to WPS screen by and . Press to confirm selection.

Result: The Daikin eye colour alternates between orange and partly green.

4 Before operation

WPS setting



- 2 Press the WPS button on your communication device (e.g. router) within approximately 1 minute. Refer to the manual of your communication device.

Result: If the connection was successful, the Daikin eye colour alternates between blue and partly green.

INFORMATION

If the connection with your router is not possible, try procedure "To connect using SSID and KEY number" [▶ 8].

- 3 Press **...** to exit to the home screen or use EXIT screen to return to "indoor unit setting menu".

To connect using SSID and KEY number

- 1 Open the ONECTA app on your smart device and follow the steps on the screen.
- 2 Connect your smart device to the same home network as the unit.
- 3 Check if the connection was successful (refer to "To confirm the wireless LAN connection status" [▶ 8]).
- 4 Press **...** to exit to the home screen or use EXIT screen to return to "indoor unit setting menu".

To confirm the wireless LAN connection status

- 1 Navigate to the status screen using **<** and **>**. Press **✓** to confirm.

Status screen



- 2 Check the Daikin eye.

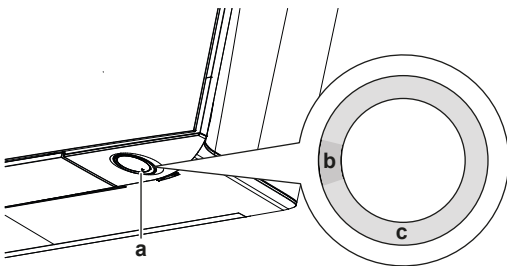

- a Daikin eye
- b Partly green
- c Red, orange or blue

Daikin eye colour alternates between partly green and...	...then wireless adapter is...
Red	not connected
orange	running and ready to connect to the home network via WPS button; see "To connect using the WPS button" [▶ 7].

Daikin eye colour alternates between partly green and...	...then wireless adapter is...
blue	connected to the home network: <ul style="list-style-type: none"> ▪ via SSID + KEY. or <ul style="list-style-type: none"> ▪ via the WPS button on the router.

- 3 Press **...** to exit to the home screen or use EXIT screen to return to the indoor unit setting menu.

To reset the connection setting to the factory default

Reset the connection setting to the factory default in case you want to:

- disconnect the wireless LAN and the communication device (e.g. router) or smart device.
- repeat the setting if the connection was unsuccessful.

- 1 Navigate to the RESET screen using **<** and **>**. Press **✓** to confirm your selection.

Result: The setting is reset to the factory default.

Reset screen



- 2 Press **...** to exit to the home screen or use EXIT screen to return to the indoor unit setting menu.

To turn off the wireless LAN connection

- 1 Enter the wireless LAN connection setting menu and change the setting to OFF using **^** and **v**. Press **✓** to confirm your selection.

Result: The Daikin eye alternates between green and white. Communication is OFF.

4.4.3 Vertical airflow function

This function helps with optimal airflow and temperature distribution in heating operation mode. You can turn this function OFF in case there is furniture or another object under the unit.

Vertical airflow OFF

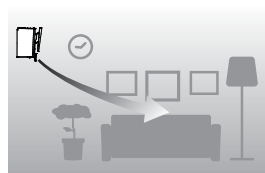

Vertical airflow ON

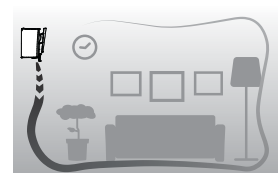

To turn ON/OFF vertical airflow function

- 1 In the indoor unit setting menu, navigate to the vertical airflow setting using **<** and **>**.

Vertical airflow function ON



Vertical airflow function OFF



- 2 Change the setting using **^** and **v**.
- 3 Press **✓** to confirm your selection.

- 4 Press again to return to the main menu or press to return to the home screen.

5 Operation

INFORMATION

The indoor unit is delivered with the wireless remote control as the user interface. This manual describes only operation with this user interface. If another user interface is connected, refer to the operation manual of the connected user interface.

5.1 Operation range

Use the system in the following temperature and humidity ranges for safe and effective operation.

	Cooling and drying ^{(a)(b)}	Heating ^(a)
Outdoor temperature	-10~46°C DB	-30~24°C DB -31~18°C WB
Indoor temperature	18~37°C DB 14~28°C WB	10~30°C DB
Indoor humidity	≤80% ^(a)	—

^(a) A safety device might stop the operation of the system if the unit runs outside its operation range.

^(b) Condensation and water dripping might occur if the unit runs outside its operation range.

5.2 Operation mode and temperature setpoint

When. Adjust the system operation mode and set the temperature when you want to:

- Heat up or cool down a room
- Blow air in a room without heating or cooling
- Decrease the humidity in a room

What. The system operates differently, depending on the user selection.

Setting	Description
Automatic 	The system cools down or heats up a room to the temperature setpoint. It automatically switches between cooling and heating if necessary.
Cooling 	The system cools down a room to the temperature setpoint.
Heating 	The system heats up a room to the temperature setpoint. Heat boost This feature is automatic; it quickly heats up your home when starting up the unit in heating mode.
Fan only 	The system only controls the airflow (airflow rate and airflow direction). During this operation you CANNOT set the temperature.

Setting	Description
Drying 	The system decreases the humidity in the room. During this operation you CANNOT set the temperature.

Additional info:

- Outside temperature.** The system's cooling or heating effect decreases when the outside temperature is too high or too low.
- Defrost operation.** During heating operation, frost might occur on the outdoor unit and decrease the heating capacity. In that case, the system automatically switches to defrosting operation to remove the frost. During defrosting operation, hot air is NOT blown from the indoor unit.
- Humidity sensor.** Control the humidity by decreasing the humidity during cooling process.

5.2.1 To start/stop operation mode and to set the temperature

Operation mode

- 1 Press to enter the operation mode carousel menu. When is pressed repeatedly, the mode will change as follows:



INFORMATION

- In the carousel menu, you can also navigate in both directions using and or and .
- The carousel menu will always start with the currently active setting.

- 2 Press to **start** operation.
- 3 The home screen changes as follows and the Daikin eye indication lamp goes ON.

Home screen when unit is ON during...		
heating, cooling, automatic operation	drying operation	fan only operation

Temperature setpoint

- 4 Press or one or more times to lower or raise the **temperature setpoint**.

Cooling operation	Heating operation	Automatic operation	Drying or fan only operation
18~32°C	10~30°C	18~30°C	No setpoint ^(a)

^(a) When using **drying** or **fan only** operation mode, you CANNOT adjust the temperature.

- 5 Press to **stop** operation.

Result: The home screen changes as follows and the Daikin eye indication lamp goes OFF.

Home screen when the unit is OFF





5 Operation

5.3 Airflow rate

INFORMATION

- When using drying operation mode, you CANNOT adjust the airflow rate setting.
- The airflow rate in heating mode will lower to avoid generating cold airflow. When temperature of the airflow rise, operation will continue at the set airflow rate.

You can adjust the strength of the airflow coming out of the indoor unit.



Setting	Description
Fan speed 1~5 	5 airflow rate levels from low to high.
Automatic 	The indoor unit adjusts its fan speed automatically according to the setpoint and indoor temperature.
Indoor unit quiet operation 	For reduction of noise coming from the indoor unit (Example: at night)

INFORMATION

If the unit reaches the temperature setpoint:





- in cooling or automatic mode. Fan will stop operating.
- in heating mode. Fan will operate in low airflow rate.

5.3.1 To adjust the airflow rate

- Press  to enter the airflow rate carousel menu. When  is pressed repeatedly, the mode will change as follows:







INFORMATION

- In the carousel menu, you can also navigate in both directions using  and  or  and .
- The carousel menu will always start with the currently active setting.

5.4 Airflow direction

The airflow direction is the direction in which the indoor unit blows its air. It does so by moving horizontal blades (flaps) or vertical blades (louvers). Adjust the airflow direction as desired and in swing or in fixed position.

Setting	Airflow direction
Vertical automatic swing 	Moves the horizontal blades (flaps) up and down.
Horizontal automatic swing 	Moves the vertical blades (louvers) from side to side.
3-D airflow direction 	Moves alternately up and down and from side to side

Setting	Airflow direction
	Stays in a fixed position.



CAUTION

ALWAYS use the wireless remote control or other user interface (if applicable) to adjust the position of the flaps and louvers. When the flaps and louvers are swinging and you move them forcibly by hand, the mechanism will break.

The movable range of the flap varies according to the operation mode. The flap will stop at the upper position when the airflow rate is changed to low during the up and down swing setting.

Comfort airflow

The unit will automatically change the direction of the airflow to heat up or cool down the room more effectively. Direct airflow from the unit will be less noticeable.

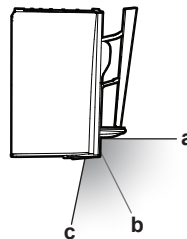

- a Flap position in cooling and dry operation
- b Flap position in heating operation (**vertical airflow OFF**)
- c Flap position in heating operation (**vertical airflow ON**)

In cooling and drying



The airflow direction will change to spread the air along the ceiling.

Comfort airflow active

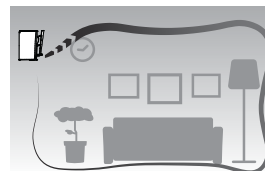

Comfort airflow disabled

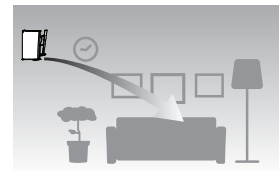

In heating

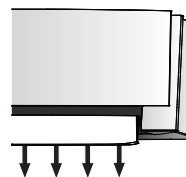

The airflow direction will change to spread the air along the floor.

If the Vertical airflow function is ON: The unit detects the room and floor temperature and automatically selects 1 of the 3 airflow directions (space warming, downward, vertical).

If the Vertical airflow function is OFF: The unit will operate only in downward airflow direction.

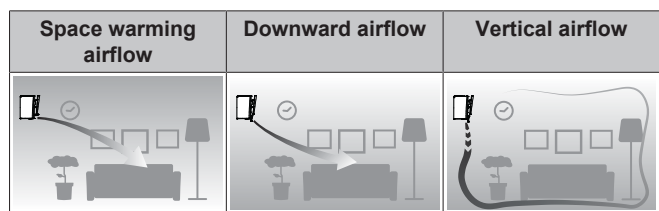

i INFORMATION

If you want to deactivate the Vertical airflow function (e.g. in case there is furniture or another object under the unit), refer to "To turn ON/OFF vertical airflow function" [p. 8]. If the Vertical airflow function is deactivated, the airflow will be set to downward direction.

i INFORMATION

Powerful and Comfort airflow operation CANNOT be used at the same time. The last selected function takes priority. If the vertical automatic swing is selected, Comfort airflow operation will be cancelled.

- 1 Enter the main menu by pressing and navigate to the airflow direction setting menu using and . Press to enter the menu.

Airflow direction setting menu

- 2 In this menu, perform the following airflow settings. Then press to return to the main menu or press to exit to the home screen.

5.4.1 To adjust vertical airflow direction

- 1 In the airflow direction setting menu, navigate to the vertical airflow screen using and .
- 2 Change the setting using and .

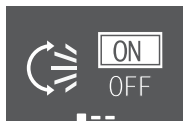
Vertical airflow - swing**Vertical airflow - fixed**

- 3 **For vertical swing.** Press to confirm your selection.

Result: appears on the bottom of the home screen. The flaps (horizontal blades) will begin to swing.

- 4 **For fixed position.** Press when the flaps reach the desired position.

Result: disappears from the bottom of the home screen. The flaps will stop moving.

5.4.2 To adjust horizontal airflow direction

- 1 In the airflow direction setting menu, navigate to the horizontal airflow screen using and .
- 2 Change the setting using and .

Horizontal airflow - swing**Horizontal airflow - fixed**

- 3 **For horizontal swing.** Press to confirm your selection.

Result: appears on the bottom of the home screen. The louvers (vertical blades) will begin to swing.

- 4 **For fixed position.** Press when the louvers reach the desired position.

Result: disappears from the bottom of the home screen. The louvers will stop moving.

i INFORMATION

When the unit is installed in a corner of a room, the direction of the louvers should be facing away from the wall. Efficiency will drop if a wall blocks the air.

5.4.3 To use 3D airflow direction

- 1 Set the vertical and the horizontal airflow to ON.
- 2 appears on the bottom of the home screen. The flaps (horizontal blades) and louvers (vertical blades) will begin to swing.

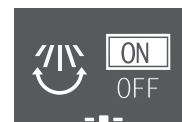
Vertical airflow ON**Horizontal airflow ON**

- 3 To use fixed position, set the vertical and the horizontal airflow to OFF when the flaps and louvers reach the desired position.

Result: disappears from the bottom of the home screen. The flaps and the louvers will stop moving.

5.4.4 To start/stop Comfort airflow operation

- 1 In the airflow direction setting menu, navigate to the comfort airflow screen using and .
- 2 Change the setting using and .

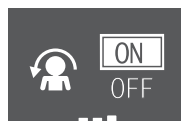
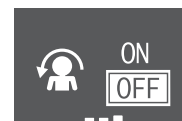
Comfort airflow active**Comfort airflow disabled**

- 3 Press to confirm your selection.

Result: Comfort airflow active: appears on the bottom of the home screen.

Result: Comfort airflow disabled: disappears from the bottom of the home screen.

5.5 Intelligent eye operation

The system detects movement in the room and automatically adjusts the airflow direction and temperature in order to avoid direct contact with people. If no movement is detected for 20 minutes, the system switches to energy saving operation:

About the Intelligent eye sensor**! NOTICE**

- Do NOT hit or push the Intelligent eye sensor. Doing so may lead to malfunction.
- Do NOT place large objects near the Intelligent eye sensor.

i INFORMATION

Night set mode (OFF timer) CANNOT be used at the same time with Intelligent eye operation.

- **Detection range.** Up to 9 m.

5 Operation

- **Detection sensitivity.** Changes according to location, the number of persons in the room, temperature range, etc.
- **Detection mistakes.** The sensor may mistakenly detect pets, sunlight, moving curtains, etc.

5.5.1 To start/stop Intelligent eye operation

1 Press to enter the main menu and navigate to the intelligent eye screen using and .

2 Change the setting using and .

Intelligent eye active



Intelligent eye disabled



3 Press to confirm your selection.

Result: Intelligent eye active: appears on the bottom of the home screen.

Result: Intelligent eye disabled: disappears from the bottom of the home screen.

5.6 Powerful operation

This operation quickly maximizes the cooling/heating effect in any operation mode. You can get the maximum capacity.

INFORMATION

Powerful operation CANNOT be used together with Econo, Comfort airflow and Outdoor unit quiet operation. The last selected function takes priority.

Powerful operation will NOT increase the capacity of the unit if it already operates at maximum capacity.

5.6.1 To start/stop Powerful operation

1 Press to enter the powerful operation pop-up menu.

2 Press or and to activate or disable the function.

Result: Powerful operation active: appears on the bottom of the home screen.

Result: Powerful operation disabled: disappears from the bottom of the home screen.

Powerful operation active



Powerful operation disabled



INFORMATION

- Powerful operation can be set only when the unit is running; the symbol on the screen indicates that the function is currently prohibited.
- If you press or if you change the operation mode, operation will be cancelled; disappears from the bottom of the home screen.

5.7 Econo operation

This is a function which enables efficient operation by limiting the maximum power consumption value. This function is useful for cases in which attention should be paid to ensure a circuit breaker will not trip when the product runs alongside other appliances.

INFORMATION

- Powerful and Econo operation CANNOT be used at the same time. The last selected function takes priority.
- Econo operation reduces power consumption of the outdoor unit by limiting the rotation speed of the compressor. If power consumption is already low, Econo operation will NOT further reduce power consumption.

5.7.1 To start/stop Econo operation

1 Press to enter the main menu and navigate to the Econo screen using and .

2 Change the setting using and .

Econo operation active

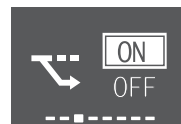

Econo operation disabled



3 Press to confirm your selection.

Result: Econo operation active: appears on the bottom of the home screen.

Result: Econo operation disabled: disappears from the bottom of the home screen.

INFORMATION

- Econo operation can be set only when the unit is running; the symbol on the screen indicates that function is currently prohibited.
- If you press , change the operation mode to fan only or set Powerful operation, Econo operation will be cancelled; disappears from the bottom of the home screen.

5.8 Outdoor unit quiet operation

Use Outdoor unit quiet operation when you want to decrease the noise level of the outdoor unit. **Example:** At night.

INFORMATION

- Powerful and Outdoor unit quiet operation CANNOT be used at the same time. The last selected function takes priority.
- This function is only available in Automatic, Cooling, and Heating operation.
- Outdoor unit quiet operation limits the rotation speed of the compressor. If the rotation speed of compressor is already low, Outdoor unit quiet operation will NOT further reduce the compressor rotation speed.

5.8.1 To start/stop Outdoor unit quiet operation

1 Press to enter the outdoor unit quiet operation pop-up menu.

Outdoor unit quiet operation active**Outdoor unit quiet operation disabled**

- 2 Press or and to activate or disable the function.

Result: Outdoor unit quiet **active:** appears on the bottom of the home screen.

Result: Outdoor unit quiet **disabled:** disappears from the bottom of the home screen.

Note: remains on the home screen, even if you turn off the unit using the wireless remote control or indoor unit ON/OFF switch.

5.9 Flash Streamer (air cleaning) operation

Streamer generates a high-speed electron stream with a high oxidizing power, reducing bad odours. Together with the titanium apatite deodorising filter and the air filters, this function cleans the air in the room.

INFORMATION

- The high-speed electrons are generated and go away inside the unit to ensure safe operation.
- The Streamer discharge may generate a fizzing sound.
- If the airflow becomes weak, the Streamer discharge may stop temporarily to prevent ozone smell.

5.9.1 To start/stop Flash Streamer (air cleaning) operation

- 1 Press to enter the main menu. The Flash Streamer screen is on the first position of the main menu.
- 2 Change the setting using and .

Flash Streamer operation active**Flash Streamer operation disabled**

- 3 Press to confirm your selection.

Result: Flash streamer operation **active:** appears on the bottom of the home screen.

Result: Flash streamer operation **disabled:** disappears from the bottom of the home screen.

5.10 Fireplace logic operation

Use Fireplace logic operation to equally distribute the hot air from an external heat source (e.g. fireplace) across the room.

INFORMATION

- If the set temperature is reached in heating mode, the operation Fireplace logic will start automatically.
- During Fireplace logic operation the indoor unit fan distributes the hot air from the external source across the room.
- The airflow rate depends on difference between set temperature and temperature in the room (higher temperature difference = higher airflow rate).

5.10.1 To start/stop Fireplace logic operation

Prerequisite: Operation mode is set to heating "5.2 Operation mode and temperature setpoint" [p. 9].

- 1 Press to enter the main menu and navigate to the Fireplace logic screen using and .
- 2 Change the setting using and .

Fireplace logic operation active**Fireplace logic operation disabled**

- 3 Press to confirm your selection.

Result: Fireplace logic operation **active:** appears on the bottom of the home screen.

Result: Fireplace logic operation **disabled:** disappears from the bottom of the home screen.

INFORMATION

Fireplace logic operation can be set only in heating operation mode; the symbol on the screen indicates that function is currently prohibited.

5.11 Clock and timer setting

- 1 Enter the main menu by pressing and navigate to the clock and timer setting menu using and . Press to enter the menu.

Clock and timer setting menu

- 2 In this menu, perform the following clock and timer setting. Then press to return to the main menu or press to exit to the home screen.

5.11.1 The clock setting

If the indoor unit's internal clock is NOT set to the correct time, the ON timer, OFF timer and weekly timer will NOT operate correctly. The clock must be set again:

- After a circuit breaker has turned the unit OFF.
- After a power failure.
- After replacing batteries in the wireless remote control.

5 Operation

To set the clock

- 1 In the clock and timer setting menu, navigate to the clock setting screen using and . Enter the setting using .

Clock setting (displays current clock setting)

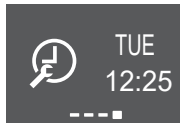

Note: If the time was not yet set, you will first enter the clock setting. No other timer setting can be done until the clock is set.

- 2 Change the day of the week using and .

Day of the week setting



- 3 Go to the hours setting using .

Hours setting



- 4 Change the hour using and (24-hour format).

- 5 Go to the minutes setting using .

Minutes setting



- 6 Change the minutes using and .

5.11.2 OFF/ON timer operation

Timer functions are useful for automatically switching the air conditioner off/on at night or in the morning. You can also use OFF timer and ON timer in combination.

INFORMATION

Program the timer again in case of:

- A breaker has turned the unit off.
- A power failure.
- After replacing batteries in the wireless remote control, the remote control keeps the time setting for the ON/OFF timer, but the timer is cancelled.

INFORMATION

The clock **MUST** be set correctly before using any timer functions. Refer to "[To set the clock](#)" 14].

To start/stop OFF timer operation

- 1 In the clock and timer setting menu, navigate to the OFF timer screen using and .

OFF timer disabled



OFF timer set to 7:00

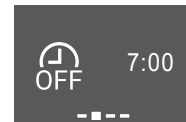

- 2 Press to enter the OFF timer setting menu.

Result: When setting the OFF timer for the first time, the current time rounded up to a 10-minute interval is displayed.

Result: When the OFF timer was already set, the last setting is displayed.

- 3 Change CANCEL to TIME using .

- 4 Go to the hour setting using and change the hour setting using and in 24-hour format.

- 5 Go to the minutes setting using and change the minutes setting using and in 10-minute intervals.

Change CANCEL to TIME

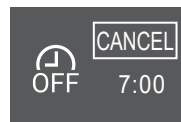

Set hours



Set minutes



- 6 Press to confirm your selection.

Result: appears on the bottom of the home screen. The set time is displayed on the OFF timer screen in the main menu. The Daikin eye lights orange. The unit will turn OFF after the set time.

- 7 **To cancel** the timer setting, go to the OFF timer setting menu and change TIME to CANCEL.

Result: disappears from the bottom of the home screen. No time is displayed on the OFF timer screen in the main menu. The Daikin eye stops lighting orange.

INFORMATION

When you set the ON/OFF timer, the time setting is stored in the memory. When the wireless remote control batteries are replaced, the remote control keeps the time setting for the ON/OFF timer, but the timer is cancelled.

Night set mode

When the OFF timer is set, the air conditioner automatically adjusts the temperature setting (0.5°C up in cooling, 2.0°C down in heating) to prevent excessive cooling/heating and ensure a comfortable sleeping temperature.

To start/stop ON timer operation

- 1 In the clock and timer setting menu, navigate to the ON timer screen using and .

ON timer disabled





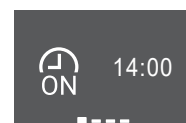



ON timer set to 14:00



- 2 Press to enter the ON timer setting menu.

Result: When setting the ON timer for the first time, the current time rounded up to a 10-minute interval is displayed.

Result: When the ON timer was already set, the last setting is displayed.

- Change CANCEL to TIME using .
- Go to the hour setting using  and change the hour setting using  and  in 24-hour format.
- Go to the minutes setting using  and change the minutes setting using  and  in 10-minute intervals.

Change CANCEL to TIME



Set hours

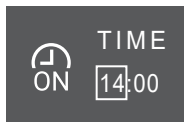

Set minutes

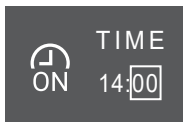

- Press  to confirm your selection.

Result:  appears on the bottom of the home screen. The set time is displayed on the ON timer screen in the main menu. The Daikin eye lights orange. The unit will turn ON after the set time.

- To cancel the timer setting, go to the ON timer setting menu and change TIME to CANCEL.

Result:  disappears from the bottom of the home screen. No time is displayed on the ON timer screen in the main menu. The Daikin eye stops lighting orange.

To combine OFF timer and ON timer

- To set the timers, refer to ["To start/stop OFF timer operation"](#) [p 14] and ["To start/stop ON timer operation"](#) [p 14].

Result:  and  are displayed on the bottom of the home screen.

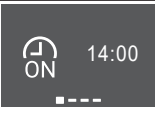
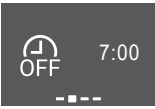
Display	Current time	Set while...	Operation
	6:00	the unit is operating.	Stops at 7:00 and starts at 14:00.
	7:00	the unit is NOT operating.	Starts at 14:00.

5.11.3 Weekly timer operation

With this operation, you can save up to 4 timer settings for each day of the week.

Example: Create a different setting from Monday to Friday and a different setting for weekends.

INFORMATION

The following setting procedure is for the wireless remote control only. However, we recommend to perform the weekly timer setting using the ONECTA app. Refer to ["4.4.2 Wireless LAN connection"](#) [p 6] for more information.

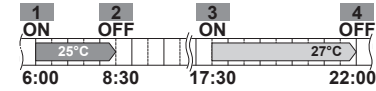
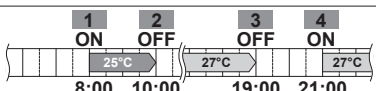
Day of the week	Setting example
Monday~Friday	
Saturday	—
Sunday	

- ON-ON-ON-ON setting.** Enables scheduling and set temperature.

- OFF-OFF-OFF-OFF setting.** Only the turn off time can be set for each day.

Note: Be sure to aim the wireless remote control at the indoor unit and check for a receiving tone when setting the Weekly timer operation.





INFORMATION

The clock MUST be set correctly before using any timer functions. Refer to ["To set the clock"](#) [p 14].

INFORMATION

- Weekly timer and OFF/ON timer operation CANNOT be used at the same time. The OFF/ON timer operation takes priority. Weekly timer will be in standby,  disappears from the home screen. When the OFF/ON timer is completed, the Weekly timer becomes active.
- The day of the week, OFF/ON timer mode, time and temperature (only for ON timer) can be set with the Weekly timer. Other settings are based on previous ON timer setting.

To set Weekly timer operation

- In the clock and timer setting menu, navigate to the weekly timer settings menu using  and .
- Change OFF to ON using  and , then press  to confirm your selection.



Result: The Daikin eye lights orange. Settings for the first day of the week will display (4 entries for each day).

Weekly timer disabled



Weekly timer active



- Navigate between days using  and . Navigate between 4 entries using  and .

Example:



Empty field – no setting for Monday

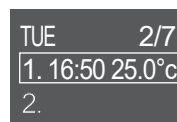

Unit starts: on Tuesday at 16:50 with 25°C temperature setpoint

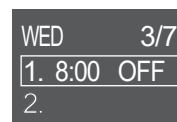

Unit stops: on Wednesday at 8:00

- Press  to enter the setting.

- Change the setting to ON, OFF or DEL.

ON timer

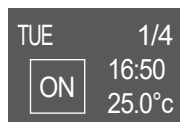

The unit starts at set time and temperature setpoint.

OFF timer





The unit stops at set time.

Delete





Deletes this entry

ON/OFF timer





- Go to the hour setting using  and change the hour setting using  and  in 24-hour format.

6 Energy saving and optimum operation

7 Go to the minutes setting using  and change the minutes setting using  and  in 10-minute intervals.

8 For **OFF timer**. Confirm the setting using .

Result: The day of the week with 4 day entries is displayed. The new entry is present in the entry list. The unit turns ON or OFF at the set time. The entry list is sorted by time.

9 For **ON timer**, you can also set the temperature setpoint. Go to the temperature setting using  and change the setpoint using  and . Confirm the setting using .

Result: The day of the week with 4 day entries is displayed. The new entry is present in the entry list. The unit starts operating with the temperature setpoint. The entry list is sorted by time.



INFORMATION

The temperature can be set between 10~32°C on the wireless remote control, however:

- in cooling and automatic operation mode, the unit will operate at minimum 18°C, even if is set to 10~17°C;
- in heating and automatic operation mode, the unit will operate at maximum 30°C, even if is set to 31~32°C.

Delete entry

1 To delete individual entries, change the setting to DEL and confirm using .

Result: The day of the week with 4 day entries is displayed. The entry is deleted. The day entry list is sorted by time.

6 Energy saving and optimum operation



INFORMATION

- Even if the unit is turned OFF, it consumes electricity.
- When the power turns back on after a power break, the previously selected mode will be resumed.



CAUTION

NEVER expose little children, plants or animals directly to the airflow.



NOTICE

Do NOT place objects below the indoor and/or outdoor unit that may get wet. Otherwise condensation on the unit or refrigerant pipes, air filter dirt or drain blockage may cause dripping, and objects under the unit may get dirty or damaged.



WARNING

Do NOT place a flammable spray bottle near the air conditioner and do NOT use sprays near the unit. Doing so may result in a fire.



CAUTION

Do NOT operate the system when using a room fumigation-type insecticide. Chemicals could collect in the unit, and endanger the health of people who are hypersensitive to chemicals.

7 Maintenance and service

7.1 Overview: Maintenance and service

The installer has to perform a yearly maintenance.

About the refrigerant

This product contains fluorinated greenhouse gases. Do NOT vent gases into the atmosphere.

Refrigerant type: R32

Global warming potential (GWP) value: 675



NOTICE

Applicable legislation on **fluorinated greenhouse gases** requires that the refrigerant charge of the unit is indicated both in weight and CO₂ equivalent.

Formula to calculate the quantity in CO₂ equivalent tonnes: GWP value of the refrigerant × total refrigerant charge [in kg]/1000

Contact your installer for more information.



NOTICE

Maintenance **MUST** be done by an authorised installer or service agent.

We recommend performing maintenance at least once a year. However, applicable legislation might require shorter maintenance intervals.



WARNING

- The refrigerant inside the unit is mildly flammable, but normally does NOT leak. If the refrigerant leaks in the room and comes in contact with fire from a burner, a heater, or a cooker, this may result in fire, or the formation of a harmful gas.
- Turn OFF any combustible heating devices, ventilate the room, and contact the dealer where you purchased the unit.
- Do NOT use the unit until a service person confirms that the part from which the refrigerant leaked has been repaired.



WARNING

- Do NOT pierce or burn refrigerant cycle parts.
- Do NOT use cleaning materials or means to accelerate the defrosting process other than those recommended by the manufacturer.
- Be aware that the refrigerant inside the system is odourless.



WARNING

The appliance shall be stored so as to prevent mechanical damage and in a well-ventilated room without continuously operating ignition sources (e.g. open flames, an operating gas appliance, or an operating electric heater). The room size shall be as specified in the General safety precaution.



DANGER: RISK OF ELECTROCUTION

To clean the air conditioner or air filter, be sure to stop operation and turn all power supplies OFF. Otherwise, an electrical shock and injury may result.



WARNING

To prevent electrical shocks or fire:

- Do NOT rinse the unit.
- Do NOT operate the unit with wet hands.
- Do NOT place any objects containing water on the unit.



CAUTION

After a long use, check the unit stand and fitting for damage. If damaged, the unit may fall and result in injury.



CAUTION

Do NOT touch the heat exchanger fins. These fins are sharp and could result in cutting injuries.



WARNING

Be careful with ladders when working in high places.

7.2 To clean the indoor unit and wireless remote control



WARNING

Improper detergents or cleaning procedure may cause damage on plastic components or water leakage. Splashed detergent on electric components, such as motors, may cause failure, smoke or ignition.



DANGER: RISK OF ELECTROCUTION

Before cleaning, be sure to stop the operation, turn the breaker OFF or pull out the supply cord. Otherwise, an electrical shock and injury may result.



NOTICE

- Do NOT use gasoline, benzene, thinner, polishing powder or liquid insecticide. **Possible consequence:** Discoloration and deformation.
- Do NOT use water or air of 40°C or higher. **Possible consequence:** Discoloration and deformation.
- Do NOT use polishing compounds.
- Do NOT use a scrubbing brush. **Possible consequence:** The surface finishing peels off.
- As an end user, you may NEVER clean inside parts of the unit by yourself; this work must be performed by a qualified service person. Contact your dealer.

- 1 Clean with a soft cloth. If it is difficult to remove stains, use water or a neutral detergent.

7.3 To clean the front panel

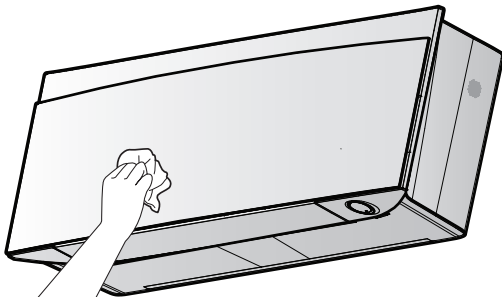

- 1 Clean the front panel with a soft cloth. If it is difficult to remove stains, use water or a neutral detergent.

7.4 To open the front panel

- 1 Stop operation by .

Result: The front panel closes automatically.

- 2 Open the front panel using the wireless remote control. See "4.4.1 Open the front panel" [p 6].

Result: The front panel opens.

- 3 Turn the power supply OFF.
- 4 Pull down both locks on the back of the front panel.
- 5 Open the front panel until the support fits into the fixing tab.

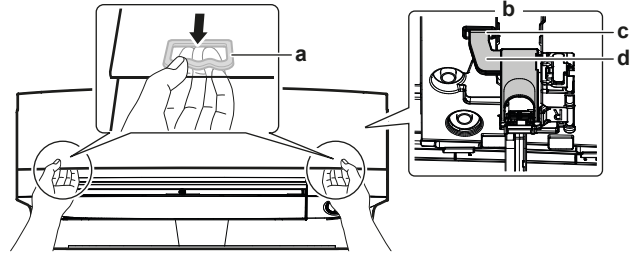

- a Lock (1 on each side)
- b Backside of the front panel
- c Fixing tab
- d Support



INFORMATION

If you CANNOT find the wireless remote control or you use another optional controller. Pull the front panel carefully up by hand as shown in the following figure.

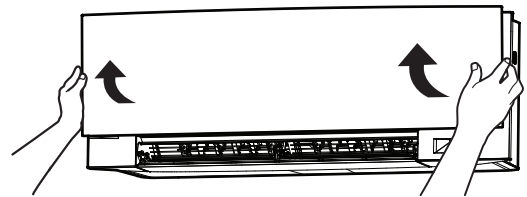

7.5 To clean the air filters

- 1 Push the tab at the centre of each air filter, then pull it down.
- 2 Pull out the air filters.

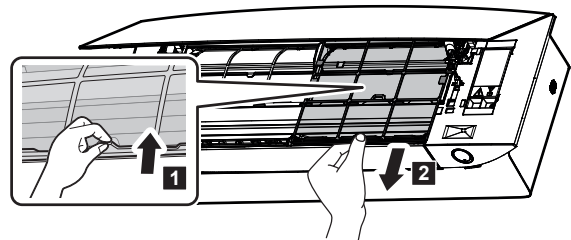

- 3 Remove the titanium apatite deodorising filter and silver particle filter from the tabs.

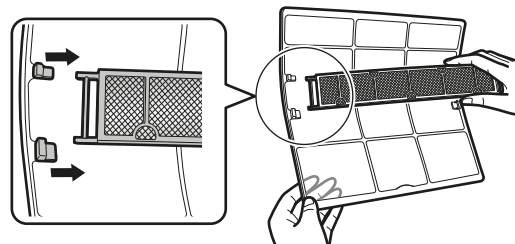

- 4 Wash the air filters with water or clean them with a vacuum cleaner.

7 Maintenance and service

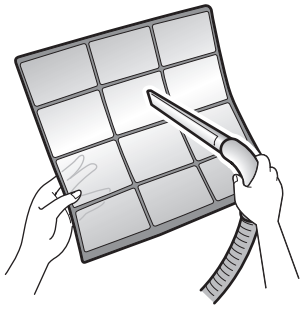

- 5 Soak in lukewarm water for about 10 to 15 minutes.

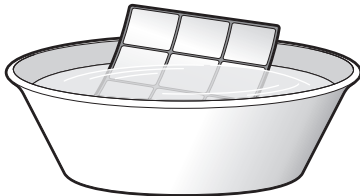

i INFORMATION

- If the dust does NOT come off easily, wash the air filters with a neutral detergent diluted in lukewarm water. Dry the air filters in the shade.
- Be sure to remove the titanium apatite deodorising and silver particle filters.
- It is recommended to clean the air filters every 2 weeks.

7.6 To clean the titanium apatite deodorising filter and the silver particle filter (Ag-ion filter)

i INFORMATION

Clean the filter with water every 6 months.

- 1 Remove titanium apatite deodorising filter and the silver allergen removal air purifying filter from all 4 claws.

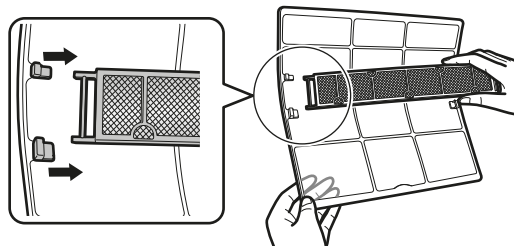

a Claw

- 2 Remove the dust from the filter with a vacuum cleaner.

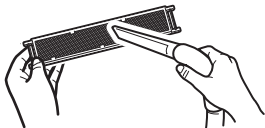

- 3 Soak the filter for 10 to 15 minutes in warm water.

Note: Do NOT remove the filter from the frame.



- 4 After washing, shake off remaining water and dry the filter in the shade. Do NOT wring out the filter when removing water.

7.7 To replace the titanium apatite deodorising filter and the silver particle filter (Ag-ion filter)

i INFORMATION

Replace the filter every 3 years.

- 1 Remove the filter from the tabs of the filter frame and replace the filter with a new one.

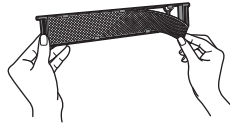

i INFORMATION

- Do NOT throw away the filter frame, but use it again.
- Dispose of the old filter as non-flammable waste.

To order titanium apatite deodorising filter or silver particle filters, contact your dealer.

Item	Part number
Titanium deodorising filter	KAF970A46
Silver particle filter	KAF057A41

7.8 To close the front panel

- 1 Set the filters as they were.
- 2 Lift the front panel slightly and remove the support from the fixing tab.

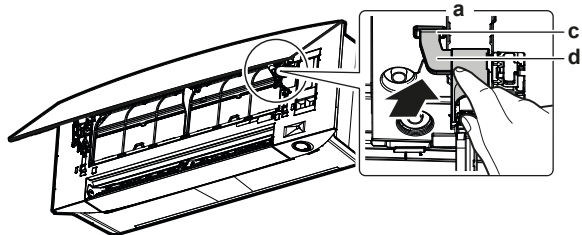

- a Backside of the front panel
- b Fixing tab
- c Support
- d

- 3 Close the front panel.

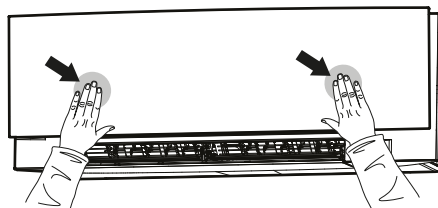

- 4 Gently press the front panel down until it clicks.

7.9 To take following items into account before a long idle period

Operate the unit several hours in **fan only** mode to dry the inside of the unit.

- 1 Set the mode to fan only, see "[5.2 Operation mode and temperature setpoint](#)" [▶ 9].
- 2 After operation stops, turn the breaker OFF.
- 3 Clean the air filters and replace them in their original positions.
- 4 Remove the batteries from the wireless remote control.

**INFORMATION**

It is recommended to have periodical maintenance performed by a specialist. For specialist maintenance, contact your dealer. Maintenance costs shall be borne by the customer.

In certain operating conditions the inside of the unit may get dirty after several seasons of use. This results in poor performance.

8 Troubleshooting

If one of the following malfunctions occur, take the measures shown below and contact your dealer.

**WARNING**

Stop operation and shut OFF the power if anything unusual occurs (burning smells etc.).

Leaving the unit running under such circumstances may cause breakage, electrical shock or fire. Contact your dealer.

The system **MUST** be repaired by a qualified service person.

Malfunction	Measure
If a safety device such as a fuse, a breaker or an earth leakage breaker frequently actuates or the ON/OFF switch does NOT properly work.	Turn OFF the main power switch.
If water leaks from the unit.	Stop the operation.
The operation switch does NOT work well.	Turn OFF the power supply.
The Daikin eye flashes and you can check the error code by the wireless remote control. To display the error code see the user reference guide of the indoor unit.	Notify your installer and report the error code.

If the system does NOT operate properly except for the above mentioned cases and none of the above mentioned malfunctions is evident, investigate the system in accordance with the following procedures.

**INFORMATION**

Refer to the reference guide located on <https://www.daikin.eu> for more troubleshooting tips. Use the search function 🔍 to find your model.

If after checking all above items, it is impossible to fix the problem yourself, contact your installer and state the symptoms, the complete model name of the unit (with manufacturing number if possible) and the installation date (possibly listed on the warranty card).

9 Disposal

**NOTICE**

Do NOT try to dismantle the system yourself: dismantling of the system, treatment of the refrigerant, oil and other parts **MUST** comply with applicable legislation. Units **MUST** be treated at a specialised treatment facility for reuse, recycling and recovery.



Copyright 2023 Daikin

DAIKIN INDUSTRIES CZECH REPUBLIC s.r.o.

U Nové Hospody 1/1155, 301 00 Plzeň Skvrňany, Czech Republic

DAIKIN EUROPE N.V.

Zandvoordestraat 300, B-8400 Oostende, Belgium

3P717028-4B 2023.03